

P01 Mono Color LED Strip Light

P01-24V-2835-120-2200K-6500K

Specification

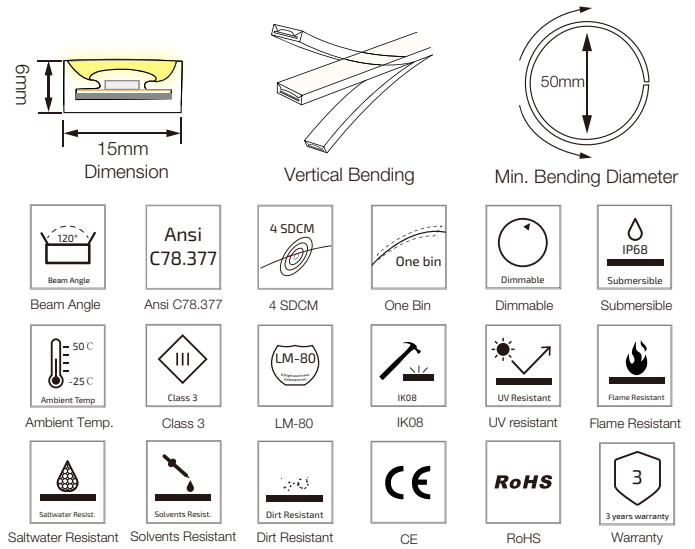

Technical Parameters

Electrical	
Input Voltage	24V DC
Power Consumption	10W/m
Physical	
LED Count	120 LEDs/m
Cutting Unit	12 LEDs
Cutting Unit Length	100mm
Minimum Bend Diameter	50mm
Output	
LED Light	Epistar SMD LED 2835
CRI	>80, >90
Max Run Length*	
Single Feed	10M
Double Feed	20M
Beam Angle	120°
Lumen Maintenance	70,000 Hours L70 @ 25°C 50,000 Hours L70 @ 50°C
Temperature Ranges	
Installation	0°C to 50°C
Operating	-25°C to 50°C
Dependability	
Warranty	3 Years Warranty
IP Rating	IP68

Optional Color	Lumen Output
	2200K(2238±102K) 930lm/m
	2700K(2725±145K) 930lm/m
	3000K(3045±175K) 953lm/m
	3500K(3465±245K) 953lm/m
	4000K(3985±275K) 970lm/m
	5000K(5029±283K) 970lm/m
	5700K(5669±355K) 990lm/m
	6500K(6532±510K) 990lm/m
	Green(520-530nm) 230lm/m
	Blue (455-465nm) 40lm/m
	Lemon Yellow(570-580nm) 300lm/m
	Pink(610-620nm) 180lm/m

Illuminance Distribution

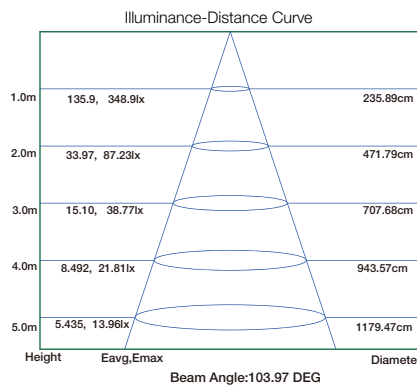
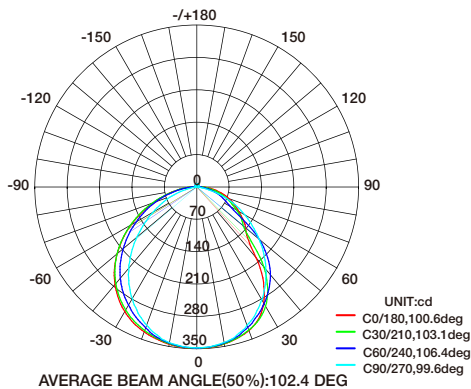

White Color Charts

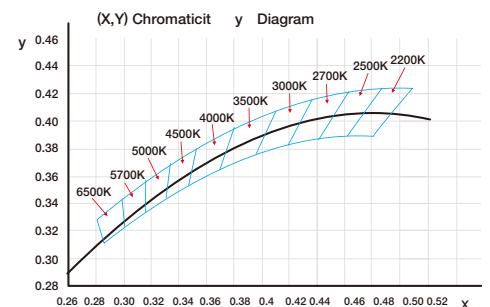

P01 Mono Color LED Strip Light

Connection

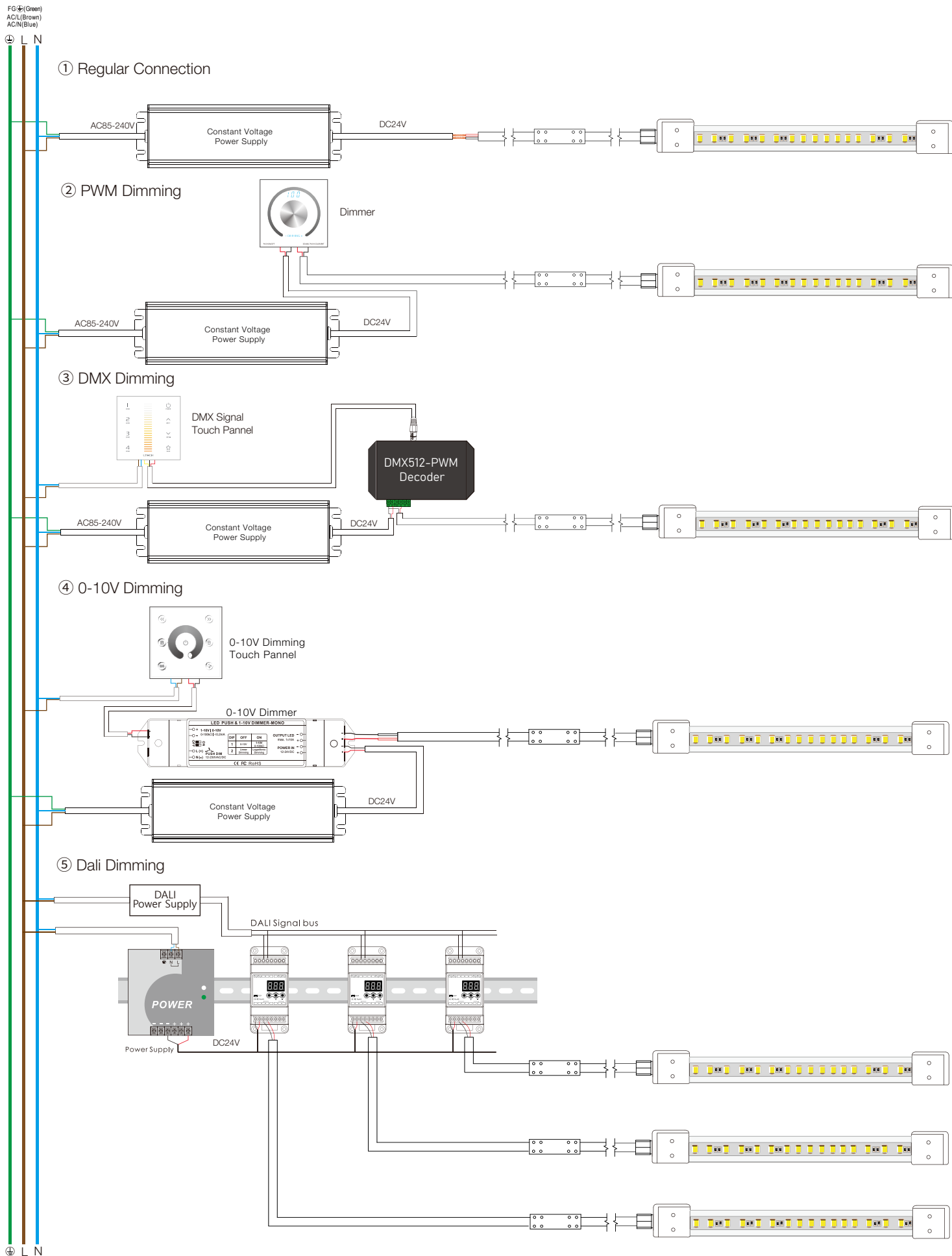

P01 Configuration and Accessories

Mold Injection Connector (IP67 Factory Assembly Only)



Direct Entry Connector
 MJ-P01-A-D01/02/03
 MJ-P01-A-D01SM
 MJ-P01-A-D02SF
 MJ-P01-A-D03SFM

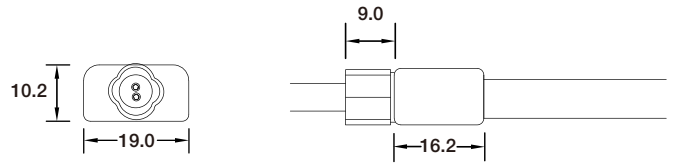

End Cap

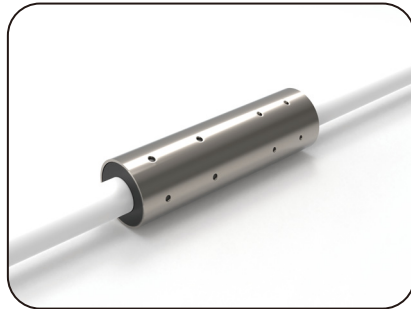
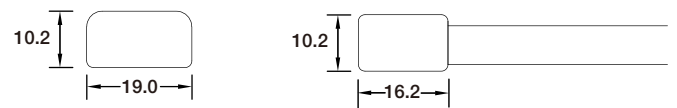

Waterproof Interrupter

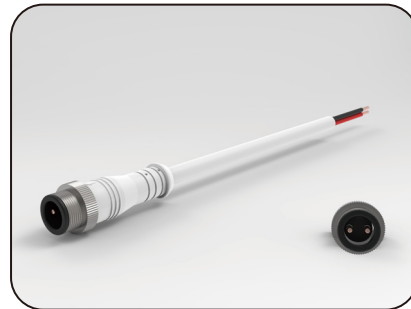
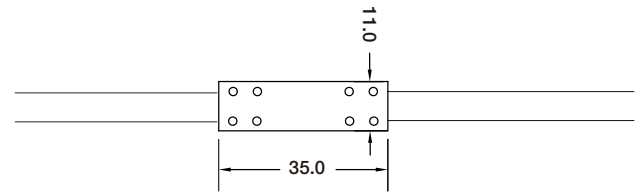

Male Connector
 SYZ-M12-M-2C-075-W

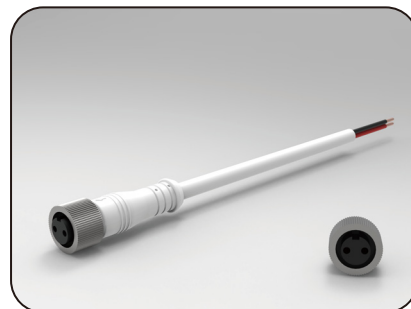
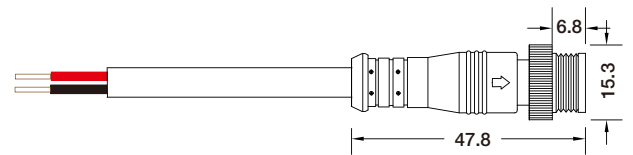

Female Connector
 SYZ-M12-F-2C-075-W

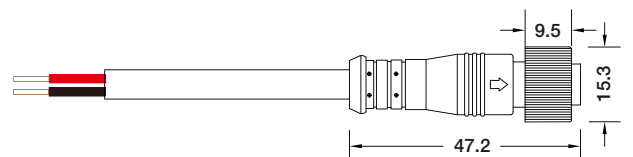

P01 Configuration and Accessories

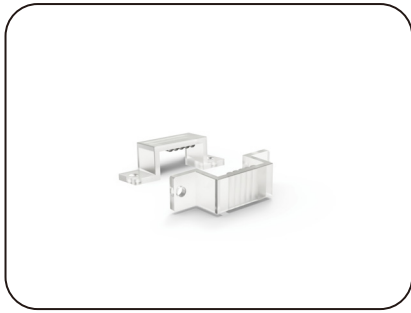

Plastic Mounting Clip
SJJ-ZSJ-006

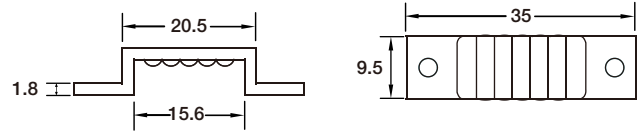

Double Coated Tissue tape
3M-4229
3m/rolls
Width: 15mm



Aluminum Mounting Channel
ALCP01S01

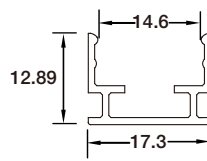

Installation Way

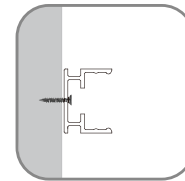

Surface Mounted

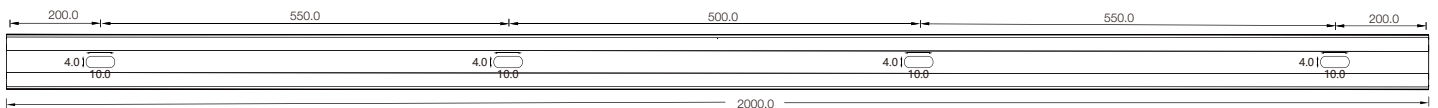
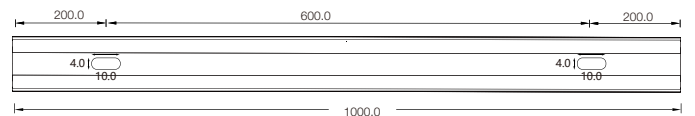
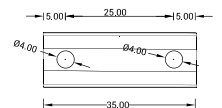
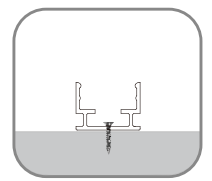

Model	W x H(mm)	Standard Length	Screw Holes	Holes Numbers	Suitable Product
ALCP01S01-035	17.3*12.89	35mm	Φ4.0mm	2	P01
ALCP01S01-100		1000mm	4.0x10mm	2	P01
ALCP01S01-200		2000mm	4.0x10mm	4	P01