

RF-DMX512 RGB LED Controller

Model No.: XC

Max 510 channel/Wireless remote control

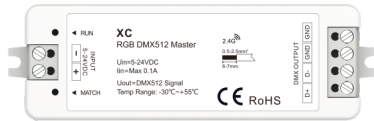

FC CE RoHS EMC LVD RED

Features

- Mini-style RF 2.4G multipixel RGB LED controller with DMX512 signal output.
- Send international standard DMX512/1990 signal to DMX512 decoders or RGB LED lamps with DMX decode chip.
- Match with Skydance's 2.4G RGB/RGBW remote control, such as R9.
- 32 kinds dynamic mode, include horse race, chase, flow, trail or gradual change style.

Technical Parameters

Input and Output	
Input voltage	5-24VDC
Power consumption	1W
Input signal	RF 2.4GHz
Output signal	DMX512
Dynamic mode	32
Control dots	Max 170 RGB pixels (510 Channels)

Environment	
Operation temperature	Ta: -30°C ~ +55°C
Case temperature (Max.)	Tc: +85°C
IP rating	IP20

Safety and EMC	
EMC standard (EMC)	EN55032:2015, EN61000-3-2:2014, EN61000-3-2:2013, EN55024:2010/A1:2015
Safety standard(LVD)	EN 61347-1:2015 EN 61347-2-11:2015
Certification	CE,EMC,LVD

Warranty and Protection	
Warranty	5 years
Protection	Reverse Polarity

Mechanical Structures and Installations

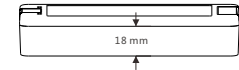
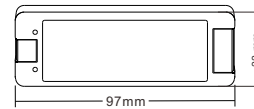

Wiring Diagram

- XC connect with DMX spot light

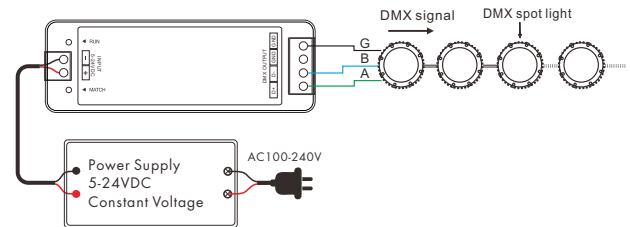

- XC connect with DMX pixel strip

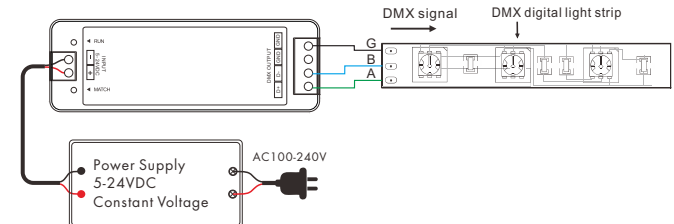

• XC connect with DMX Digital light tube

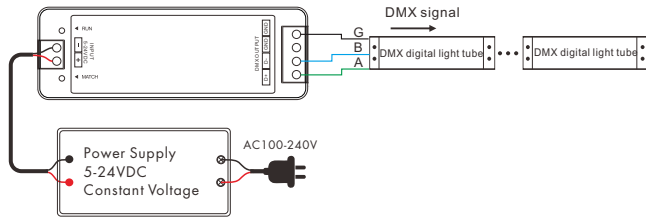

• XC connect with DMX-PWM three channel decoder

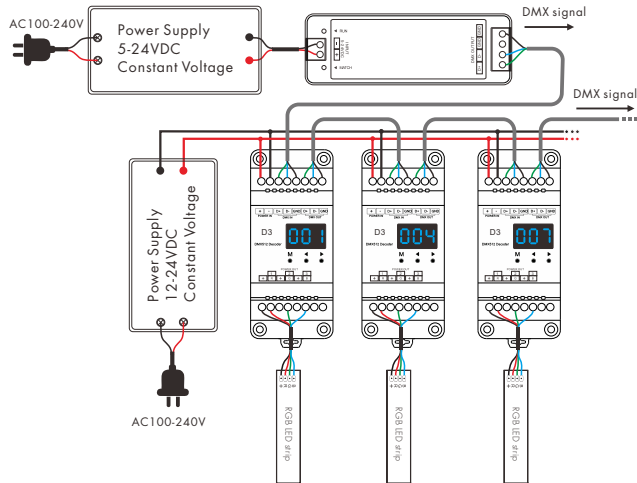

Note:

1. DMX decoder first address set in sequence as 1, 4, 7, 10, ...
2. For D3 decoder, CH1/CH2/CH3 channel corresponding to R/G/B channel output.

Match Remote Control

Match:

Short press match key, immediately press on/off key of the remote.

Delete:

Press and hold match key for 5s to delete all match, The light blinks 5 times means all matched remotes were deleted.

Dynamic mode list

No.	Name	No.	Name	No.	Name
P01	Red horse race white ground	P12	Blue White chase	P23	Purple float
P02	Green horse race white ground	P13	Green Cyan chase	P24	RGBW float
P03	Blue horse race white ground	P14	RGB chase	P25	Red Yellow float
P04	Yellow horse race blue ground	P15	7 color chase	P26	Green Cyan float
P05	Cyan horse race blue ground	P16	Blue meteor	P27	Blue Purple float
P06	Purple horse race blue ground	P17	Purple meteor	P28	Blue White float
P07	7 color multi horse race	P18	White meteor	P29	6 color float
P08	7 color horse race close + open	P19	7 color meteor	P30	6 color smooth sectionally
P09	7 color multi horse race close + open	P20	Red float	P31	7 color jump sectionally
P10	7 color scan close + open	P21	Green float	P32	7 color strobe sectionally
P11	7 color multi-scan close + open	P22	Blue float		

Malfunctions analysis & troubleshooting

Malfunctions	Causes	Troubleshooting
No light	1. No power. 2. Wrong connection or insecure.	1. Check the power. 2. Check the connection.
Wrong color	1. DMX decoder start address error. 2. Wrong connection of R/G/B wires.	1. Check the DMX start address. 2. Reconnect R/G/B wires.
No response from the remote	1. The battery has no power. 2. Beyond controllable distance. 3. The controller did not match the remote.	1. Replace battery. 2. Reduce remote distance. 3. Re-match the remote.